

*ChemScan® Process Analyzers
by ASA, Inc.*

Effective 1/1/03

**We have Moved to a larger facility.
Please note our new address
and phone numbers.**

Phone 262-717-9500 Fax 262-717-9530

Visit us at www.chemscan.com

Applied Spectrometry Associates, Inc.

**ASA, Inc.
2325 Parklawn Drive, Suite I
Waukesha WI 53186**

Technical Publication

**Title: Data Summary: Denitrification Process Monitoring
Demonstration Project
Addendum 1, dated May 12, 1997**

ASA Publication Number: 29

**Prepared for: Hookers Point
Advanced Waste Treatment Facility
Tampa, FL
June 1, 1993**

**Note: This document was originally published by
Biotronics Technologies, Inc. in conjunction
with the ChemScan Process Analyzer
technology base, now owned by Applied
Spectrometry Associates, Inc. Please direct
all inquiries and correspondence to:**

**Applied Spectrometry Associates, Inc.
W226 N555G Eastmound Drive
Waukesha, WI 53186**

**Phone: (414) 650-2280
FAX: (414) 650-2285**

ChemScan™ UV-6100 Process Analyzer

DATA SUMMARY DENITRIFICATION PROCESS MONITORING DEMONSTRATION PROJECT ADDENDUM 1, DATED MAY 12, 1997

Hookers Point
Advanced Waste Treatment Facility
Tampa, Florida

Published by:

Biotronics Technologies, Inc.
W226 N555G Eastmound Drive
Waukesha, WI 53186
(414) 896-2650

June 1, 1993

Copyright 1993
Biotronics Technologies, Inc.

Project Summary

The purpose of this project was to demonstrate the capability of the UV-6100 Process Analyzer to perform on-line analysis of nitrate and nitrite for control of a denitrification process at an Advanced Wastewater Treatment (AWT) facility in central Florida. The information summarized in this report is from a demonstration project conducted during April and May of 1993.

The demonstration was conducted at the Hooker's Point AWT Facility in Tampa Florida. Appendix A contains a brief process description and flow schematic of this 60 MGD facility.

The normal method of control for the denitrification process at the AWT facility is to feed methanol based on a flow proportioned feed rate which is manually trimmed based on the results from a periodic denitrified effluent grab sample that has been analyzed by the operator using a field test kit nitrate analysis (feed back control). One objective of the demonstration was to show that the nitrate concentration of the influent to the process could be continuously monitored by the UV-6100 and that this information could be used to establish a control strategy based on nitrate demand (feed forward control signals) which can automatically be adjusted based on continuous monitoring of denitrified effluent nitrate concentration (feed back trim signals).

Analyzer Description

The UV-6100 Process Analyzer is an on-line spectrometry system equipped with a multichannel array detector and an internal computer. This system is capable of simultaneously detecting numerous wavelengths of spectral information in the ultraviolet waverange from process solutions in a flow cell or optical probe. The information is processed by the analyzer and compared to calibration files stored in memory in order to calculate the concentrations of chemical substances that cause absorbance of ultraviolet light in specific patterns. The UV-6100 Analyzer detects and analyzes the natural light absorbance characteristics of the process solution and does not use ion selective electrodes or chemical reagents to perform the analysis.

Figure 1 is an illustration of the ChemScan Analyzer. The upper enclosure contains the light source, power supplies, temperature controls, spectrograph, computer board, communications boards, control panel and associated electronics. The lower enclosure (shown without the front panel) contains a flow cell, control valve, and connection points for analog or serial communications.

Denitrification Influent Tests

A side stream from the flow channel that supplies nitrified effluent to a bank of deep bed denitrification sand filters is continuously being circulated through one channel of a composite sampling system. The UV-6100 Analyzer was calibrated using a combination of laboratory and process samples for a nitrate-nitrogen range of 0 to 25 ppm, with most values falling in the 10 to 15 ppm range. Process samples were grabbed from the trough of the composite sampler and were analyzed on site using a field analysis kit and in the laboratory using an automated flow injection analyzer with a cadmium reduction column.

A sample line was connected from the trough of the composite sampler to the UV-6100. A peristaltic pump controlled by the UV-6100 internal computer was used to deliver a fresh supply of sample through the flow cell. Sample lines were automatically flushed for a minimum of one minute intervals prior to each reading. Information from the analyzer was recorded in several ways.

The UV-6100 Analyzer was programmed to halt the sample flow through the flow cell, scan the sample and calculate nitrate-nitrogen concentration at periodic (five minute or less) intervals. This information was converted to a 4-20 mA signal by the UV-6100 Analyzer, with output to the plant data management network where the information was available for recording or display by the plant computer system.

The UV-6100 Analyzer contains an internal memory available to accumulate an historical record of data from the analyzer over a period of time. This data log capability was used to accumulate a running record of nitrate concentrations as measured by the analyzer at periodic (hourly or less) intervals during the demonstration period.

In addition, operators were requested to extract grab samples from the sample trough at least once per shift throughout the demonstration period. At the time the sample was extracted, the operator was also asked to record the most recent nitrate-nitrogen value as shown on the display panel of the UV-6100 Analyzer. In this manner, nitrate-nitrogen values from the laboratory analysis of the samples could be matched with the comparable values from the analyzer at or near the time when the sample was obtained. If a UV-6100 reading was not recorded by the operator, information from the internal data log or plant computer records could be obtained.

Denitrification Influent Results

Several graphs are attached which illustrate results from on-line analysis of the influent to the denitrification process ("on" filter values):

- HPONC01:** UV-6100 calibrations are constructed by building a set of files that contain the spectral characteristics of numerous samples and the corresponding concentrations of the analytes in each sample. The calibration files for the denitrification Influent demonstration include a combination of laboratory prepared samples with known analyte values and process samples with analyte values based on a second method of analysis. This graph shows the results obtained when field test kit values for the denitrification influent samples were used to calibrate the UV-6100. This graph illustrates poor agreement between the spectral patterns observed by the analyzer and the corresponding nitrate-nitrogen values based on test kit analysis. Although the average error was only 0.003 ppm, the variance was 1.111 ppm and the correlation using this calibration was no better than 0.84 (R^2 Value).
- HPONC02:** This graph illustrates much better agreement when nitrate-nitrogen values based on laboratory analysis of the samples were used for calibration. Although the average error was slightly higher at 0.009 ppm, the variance improved to 0.025 ppm and the correlation was nearly perfect at 0.997.
- HPLTTREN:** This is a graph of hourly nitrate-nitrogen values for the influent to the denitrification process as recorded by the UV-6100 Analyzer over the period of April 2-20, 1993. Note that a daily diurnal pattern can be observed and that the influent concentration is typically in the 15 to 20 ppm range, but both high and low concentration excursions can be noted for several periods. Breaks in the graph represent periods when the analyzer was off line for maintenance or other reasons.
- HPDNI01:** This graph shows a comparison between the hourly results from field test kit analysis of grab samples by the plant operators, laboratory analysis of grab samples obtained by the operators once per shift and the hourly UV-6100 Analyzer values from operator records or the UV-6100 internal data log. These data are for a five day period from April 21-26, 1993. Observe that there is closer agreement between the laboratory values and the UV-6100 values than between the field test kit and the UV-6100. It should be noted that the UV-6100 was calibrated using laboratory analysis values and that good agreement between these values should be expected. Although the test kit values show a significant offset when compared to either the laboratory values or to the UV-6100 results, a similar pattern can be seen in the data sets from each method.

- HPDNI04:** An adjustment capability is available in the UV-6100 which allows a constant value to be added to or subtracted from each reading. The purpose of this adjustment is to permit the analyzer to report results which correspond to some other method or instrument. An example of this is shown using results from the Tampa AWT facility. The UV-6100 was calibrated using laboratory analysis values, as explained above. Had a -8.0 ppm constant adjustment been used with the April 21-26 data, there would have been excellent agreement (average error of under 0.20 ppm) between the test kit results and the adjusted UV-6100 values, as shown on the graph. This demonstrates that, if desired, the UV-6100 can emulate the results obtained from another method, as long as the results can be expected to follow a similar trend over a given concentration range.
- HPTREND:** This graph compares the nitrate-nitrogen results from laboratory analysis of periodic grab samples with the corresponding UV-6100 values at the time the sample was obtained. Excellent agreement between these values can be observed, with an average error of less than 0.50 ppm over the range of 10.0 to 26.0 ppm.
- HPDNI02:** The accuracy of the UV-6100 Analyzer is illustrated by showing the location of nitrate-nitrogen values from the UV-6100 compared to a laboratory analysis value. The standard deviation was approximately 1.0 ppm. Within the 13-18 ppm range, which was the expected operating range, nearly all values fall within plus or minus 1 standard deviation of the laboratory result. The UV-6100 contained very few calibration files in the range above 20 ppm, which may explain the diminished comparative accuracy in this range.
- HPDNI03:** Nearly all UV-6100 Analyzer nitrate-nitrogen values fall within plus or minus two standard deviations (approximately 2.0 ppm) of the laboratory results.

Denitrification Influent Calibration

with Field Test Kit Values

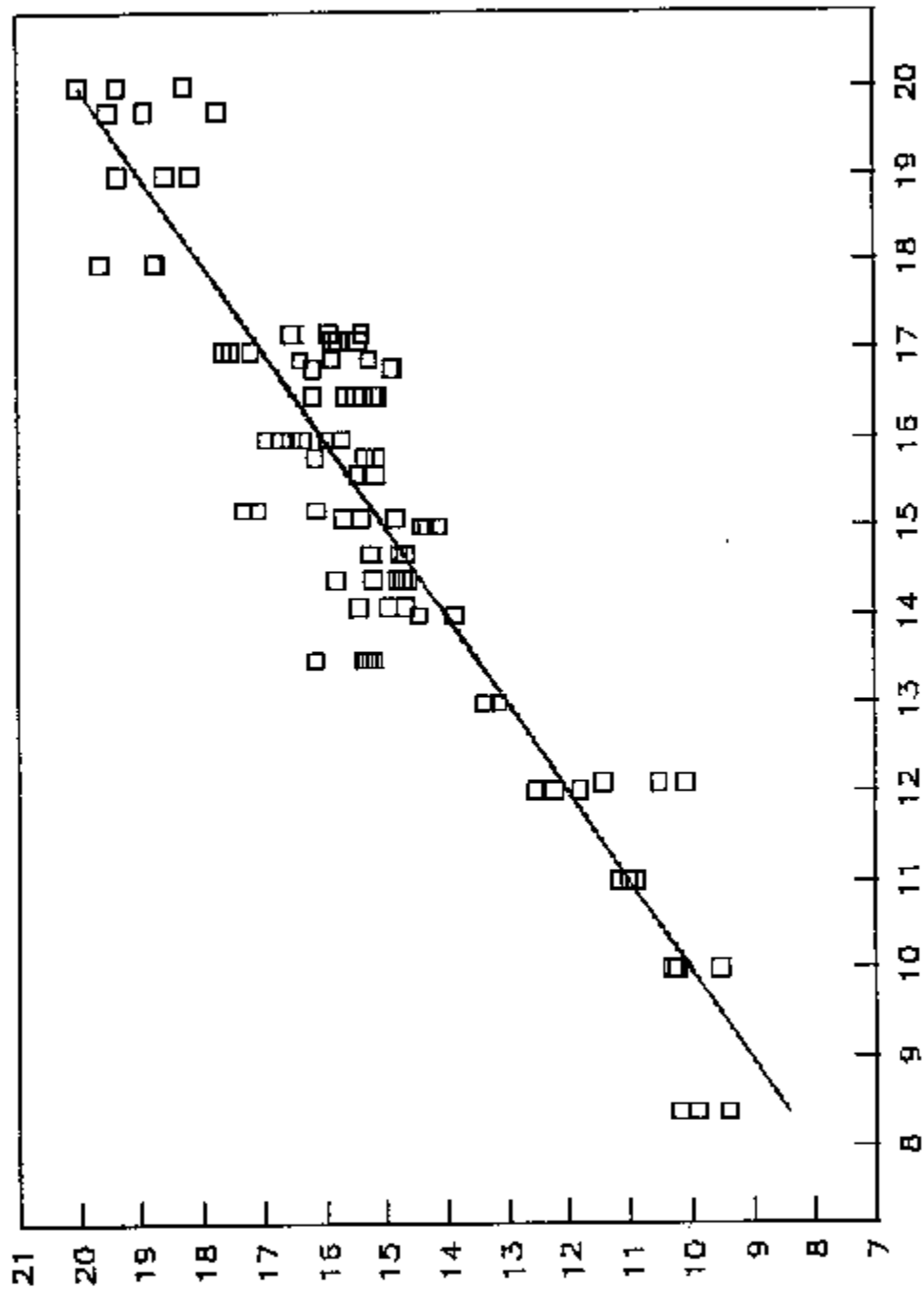

ppm, NO3-N

□ UV-6100 Algorithm — Field Standard

Denitrification Influent Calibration

with Laboratory Values

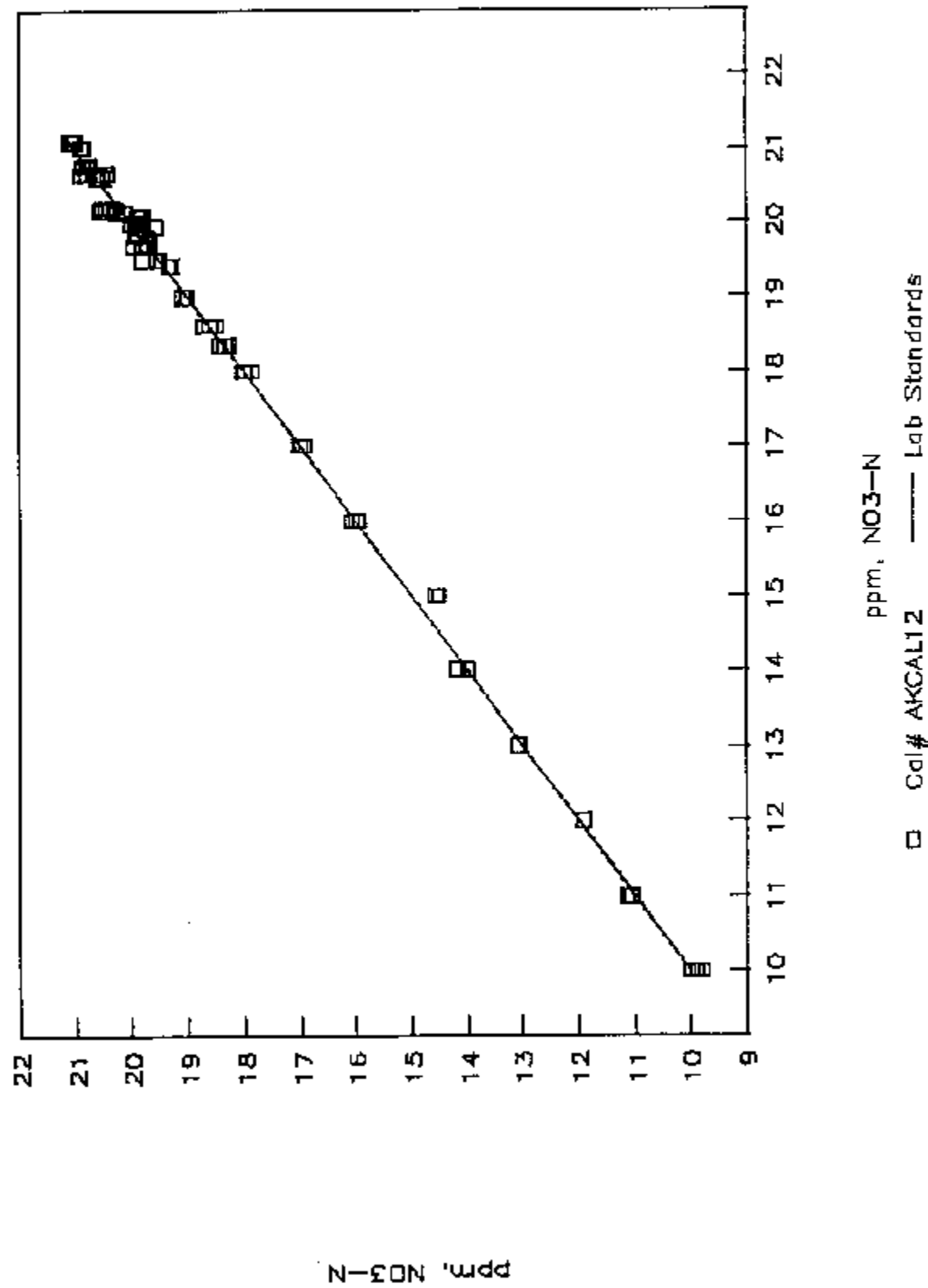

Denitrification Influent Calibration

with Laboratory Values

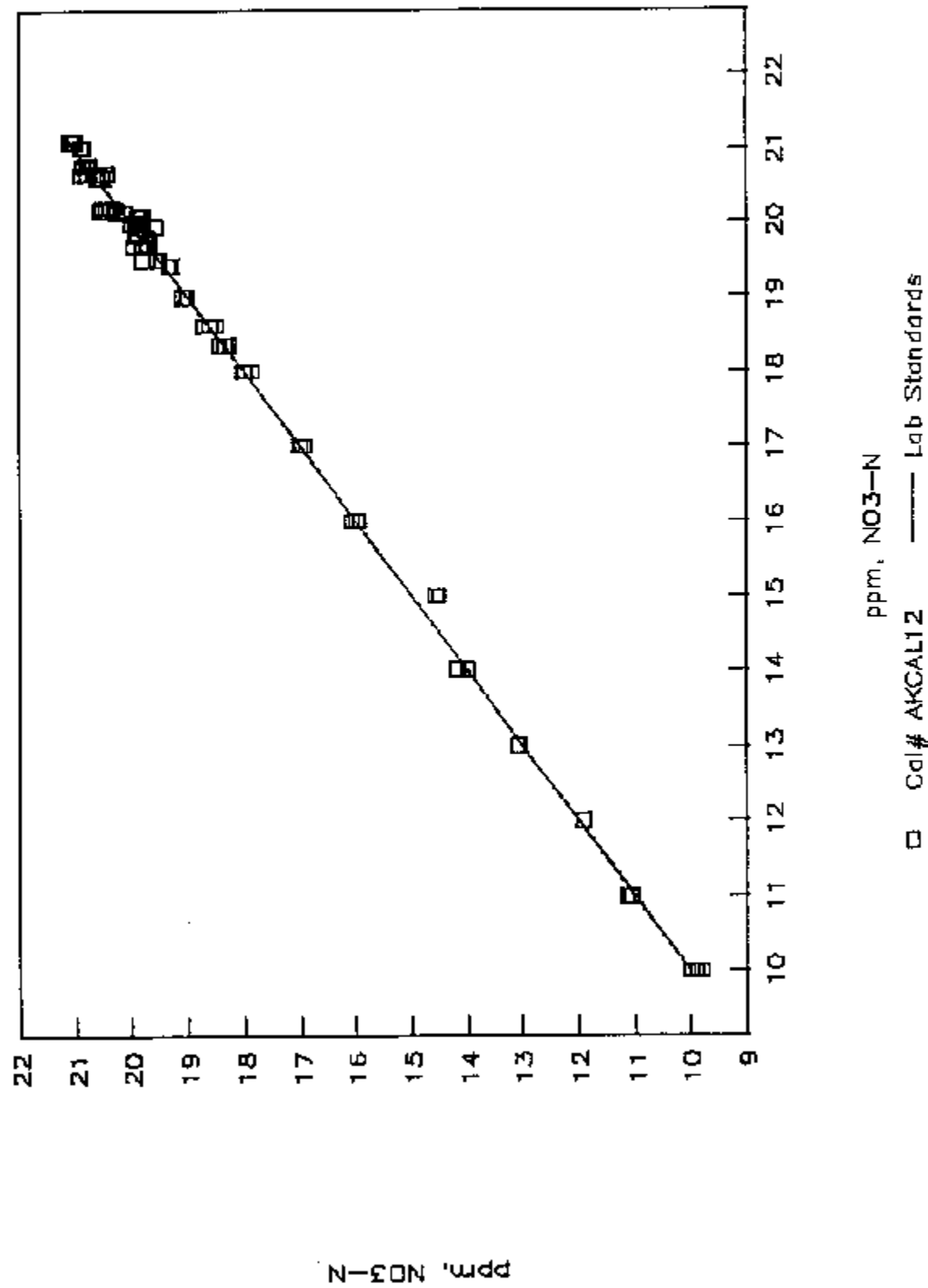

HOOKER'S POINT NITRATE TREND

"ON" FILTERS, APR. 2--20

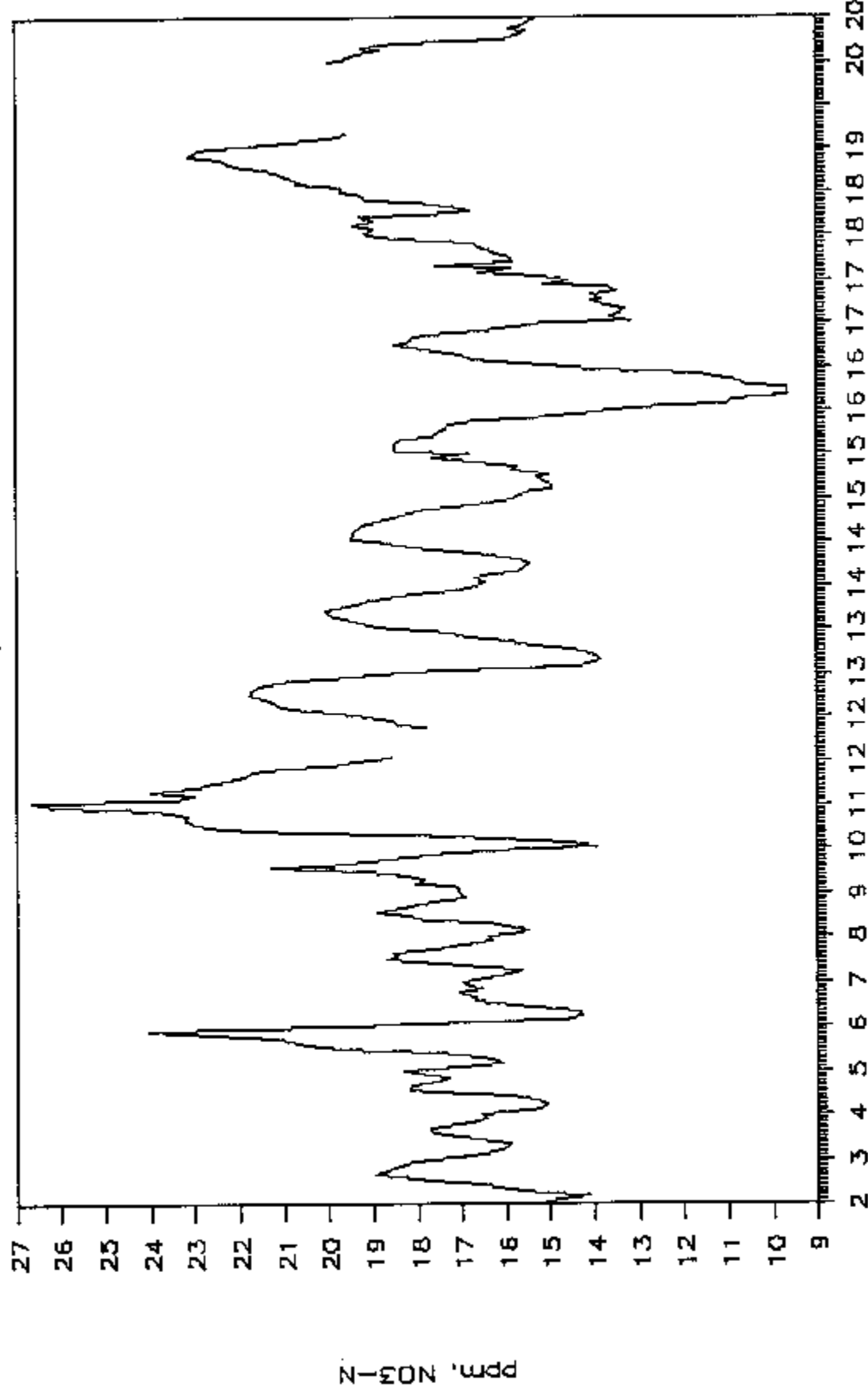

DAY OF APRIL

Tampa Florida AWT Facility

Influent to Denitrification Process

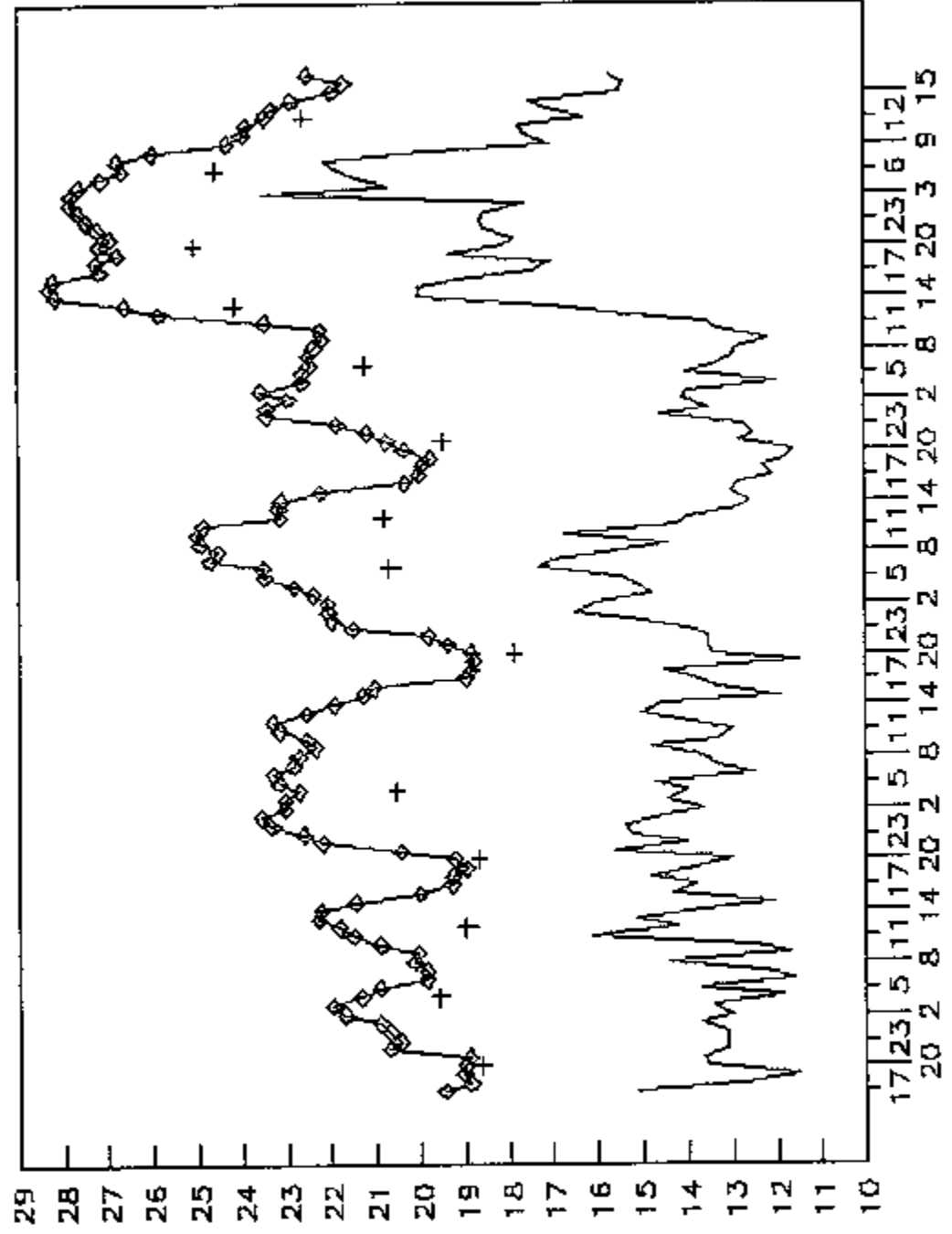

Hourly Data Starting 5pm, 4-21-93

— Operator Test Kit + Lab Analysis ◇ On-Line Analyzer

PPM, NO3-N

Tampa Florida AWT Facility

UV-6100 with -8.0ppm Offset

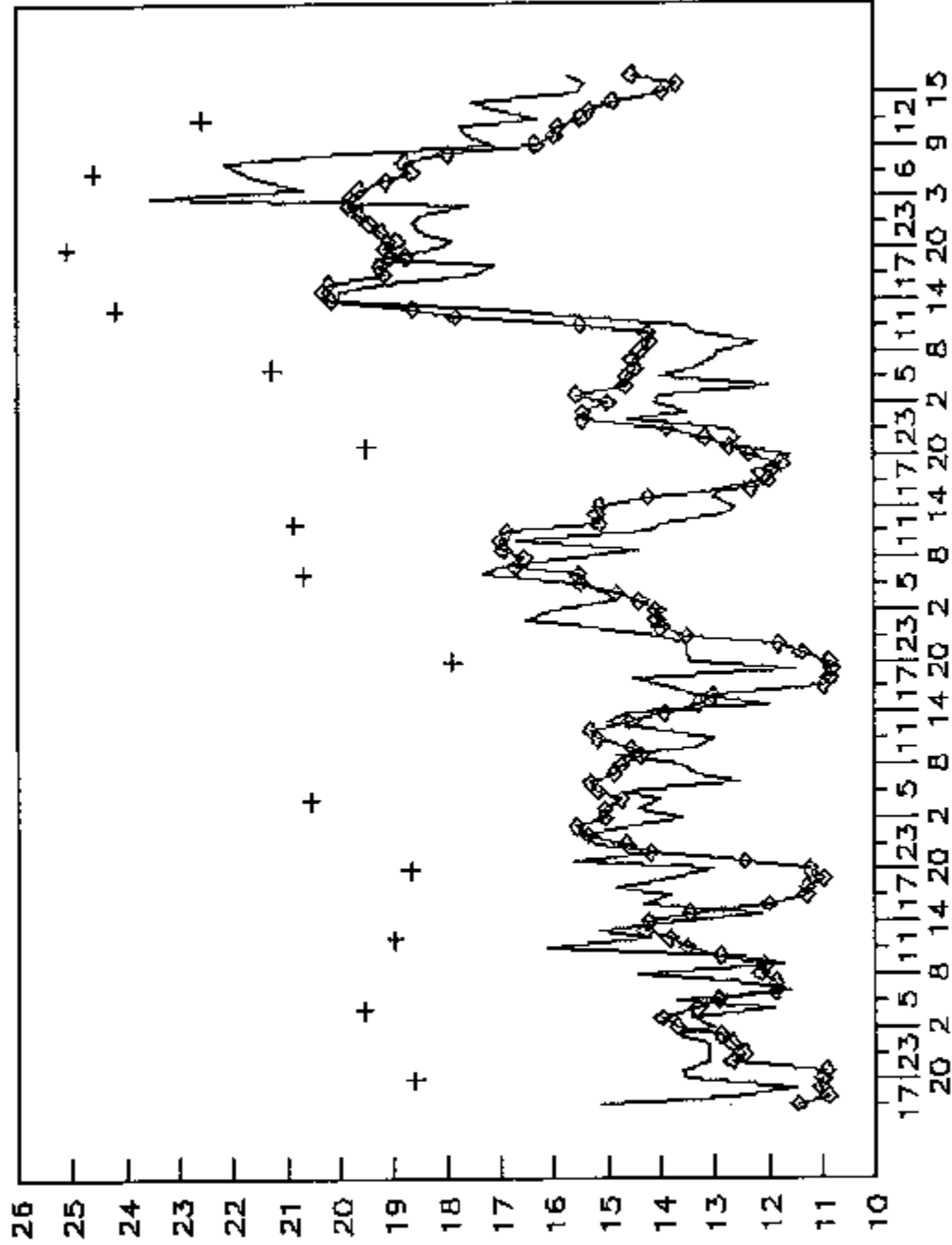

Hourly Data Starting 5pm, 4--21--93

— Operator Test Kit + Lab Analysis ◇ On-Line Analyzer

HOOKERS POINT WWTP

NITRATE COMPARISON

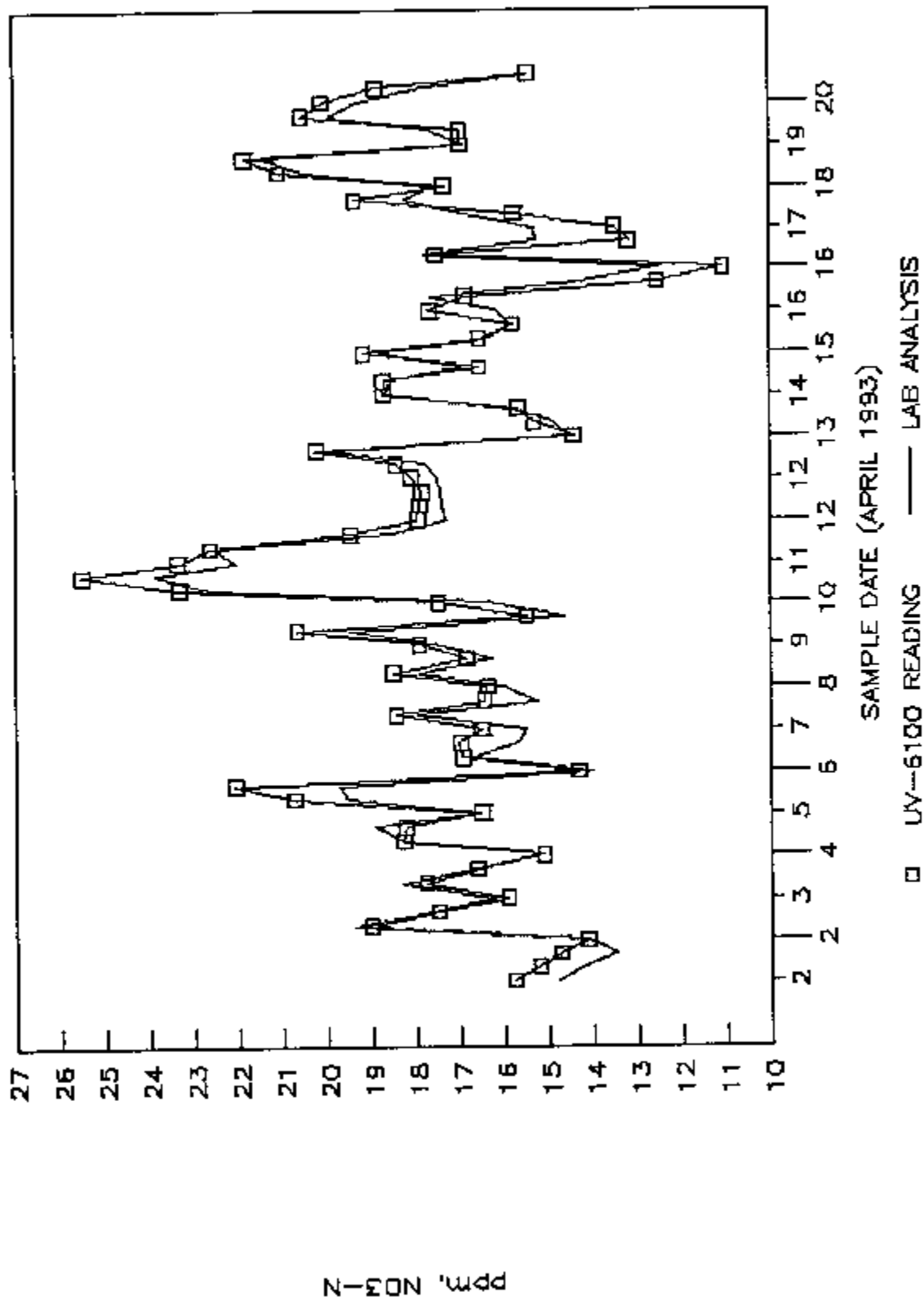

Tampa Florida AWT Facility

Influent to Denitrification Process

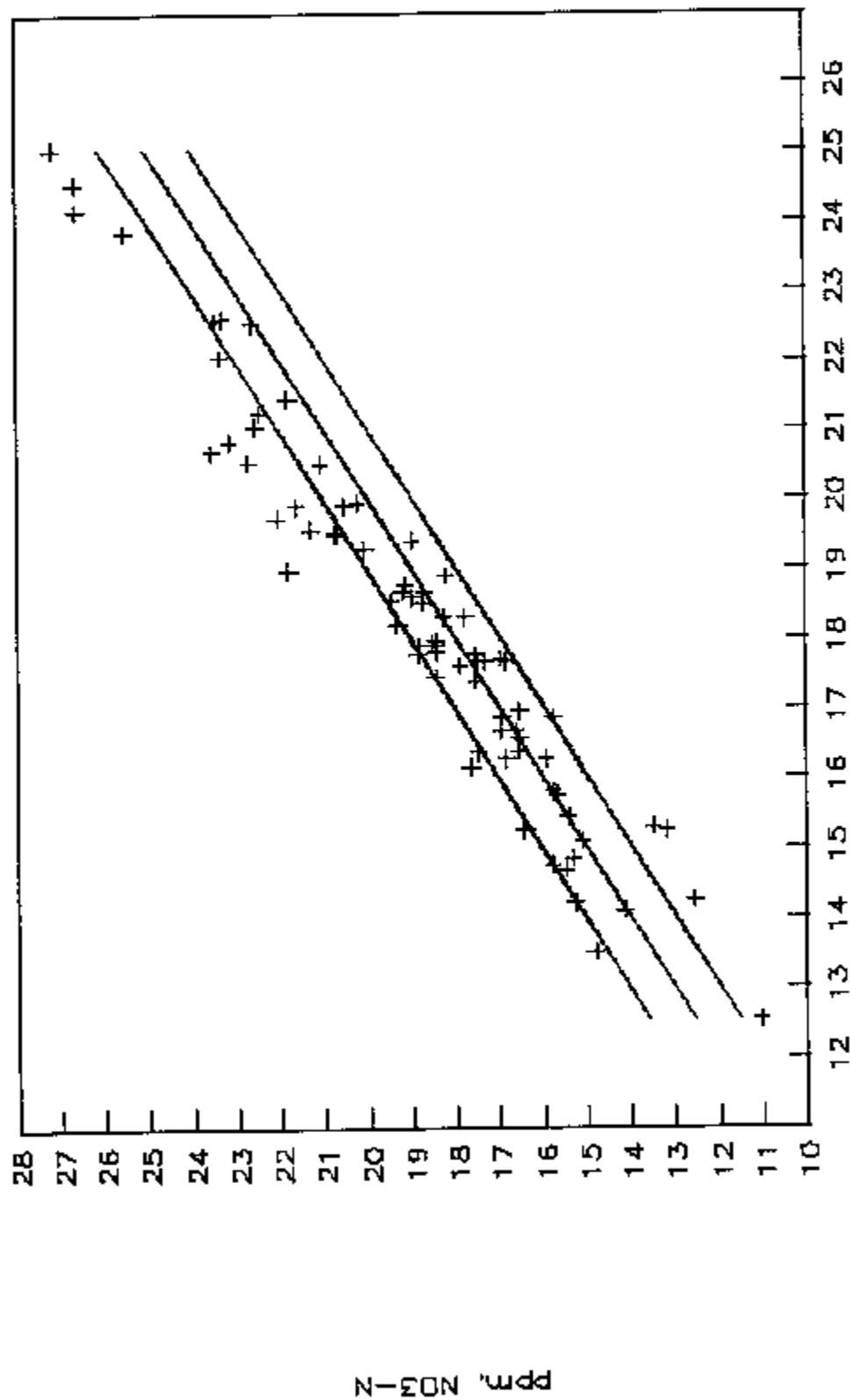

Lab Analysis vs UV-6100

— Lab Analysis + UV-6100 Analyzer — Lab + 1 S.D. — Lab - 1 S.D.

Denitrification Effluent Tests

Side streams from two banks of denitrification filters are also supplied to individual channels of the composite sampling system. In a manner similar to that used for the influent study, a sample line was connected from the "new filter" trough of the composite sampler to the UV-6100 in order to monitor the effluent from the denitrification process in this bank of filters.

The UV-6100 Analyzer was calibrated using a set of laboratory and process samples over a range of 0-5 ppm for nitrate-nitrogen and 0-5 ppm for nitrite-nitrogen. Unlike the calibration for the influent to the denitrification process, the calibration files for denitrification effluent using values from the field test kit produced better results than a calibration using values from laboratory analysis of the samples. This was believed to be the result of both better accuracy for low concentration analysis using the field test kit and sample age difficulties with the laboratory analysis.

Individual 4-20 mA channels were assigned to communicate nitrate-nitrogen and nitrite-nitrogen values from the UV-6100 Analyzer over the plant data management network. The analyzer was programmed to perform a new analysis every five minutes, although two minute intervals were also used for several days during the demonstration period. UV-6100 values were logged using the internal data log feature at intervals of one hour or less.

Log values from the UV-6100 Analyzer were compared to values from grab samples obtained once each hour by the operators from the trough of the composite sampler. In addition, a sample for laboratory analysis was obtained once per shift.

Denitrification Effluent Results

Additional graphs are attached which illustrate the results from on-line analysis of the effluent from the denitrification process ("off filter values):

- HPOFFC01:** This graph illustrates the correlation obtained when values from field test kit analysis of samples were used in the calibration for denitrification effluent nitrate-nitrogen over the range of 0 to 2.5 ppm. An average error of 0.008 ppm and a variance of 0.022 ppm were obtained, with a correlation in excess of 0.95 (R^2 value). A calibration using laboratory analysis results was attempted, but was unsuccessful. Laboratory analysis was only performed only once per week and the presence of denitrifying bacteria in the unacidified fraction of these samples resulted in unreliable nitrate-nitrogen values.
- HPDNE01:** UV-6100 Analyzer values for nitrate-nitrogen and nitrite-nitrogen are shown at ten minute intervals over a 48 hour period. Both nitrate and nitrite results show a similar pattern over this period.
- HPOFFN03:** This graph shows the variation in effluent nitrate-nitrogen values as measured by the UV-6100 Analyzer at ten minute intervals over a 30 hour period compared to the designated upper and lower control limits for the denitrification process. Note that a majority of the values are outside of the control limits.
- HPDNE04:** A comparison between the hourly field test kit values and the corresponding UV-6100 Analyzer values for nitrate-nitrogen over a one week period are shown. Excellent agreement between these data can be observed during this period, with an average error of -0.177 ppm and a variance of 0.220 ppm over a range of 0.01 to 2.7 ppm.

- HPDNE03:** This graph provides an hourly comparison of field test kit values and UV-6100 Analyzer values for nitrate-nitrogen in denitrified effluent over a 48 hour period. This less dense presentation of comparative data shows the excellent tracking achieved by the UV-6100 Analyzer.
- HPDNE05:** The accuracy of the UV-6100 Analyzer effluent measurements are shown. Analyzer nitrate-nitrogen values are compared to the reference values from the field test kit analysis, plus or minus one standard deviation of 0.47 ppm.
- HPDNE08:** Nearly all UV-6100 Analyzer nitrate-nitrogen values are shown within plus or minus two standard deviations (0.94 ppm) of the field test kit values.

Denitrification Effluent Calibration

with Field Test Kit Values

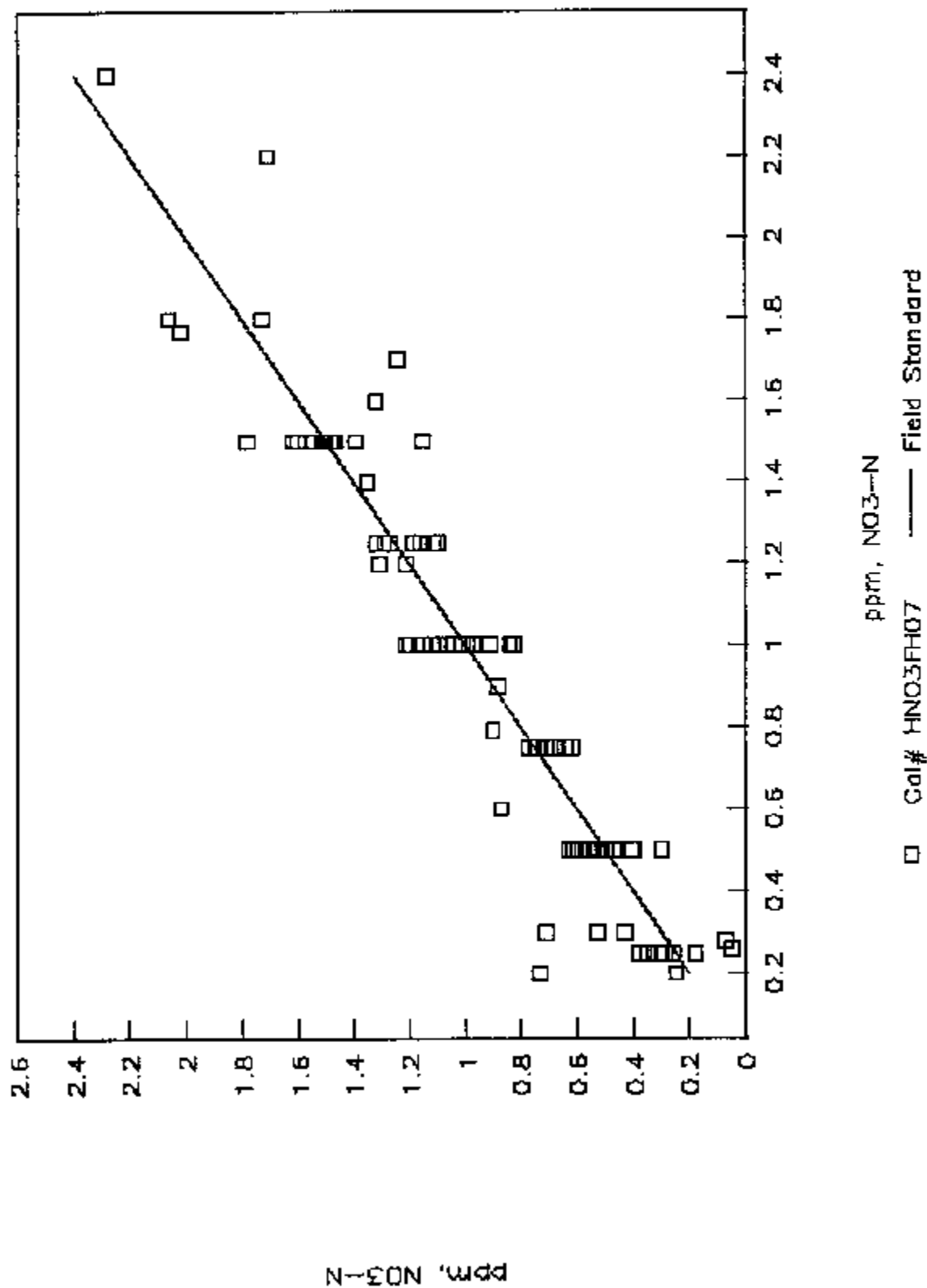

ppm, NO3-N

51

Tampa Florida AWT Facility

Denitrification Effluent

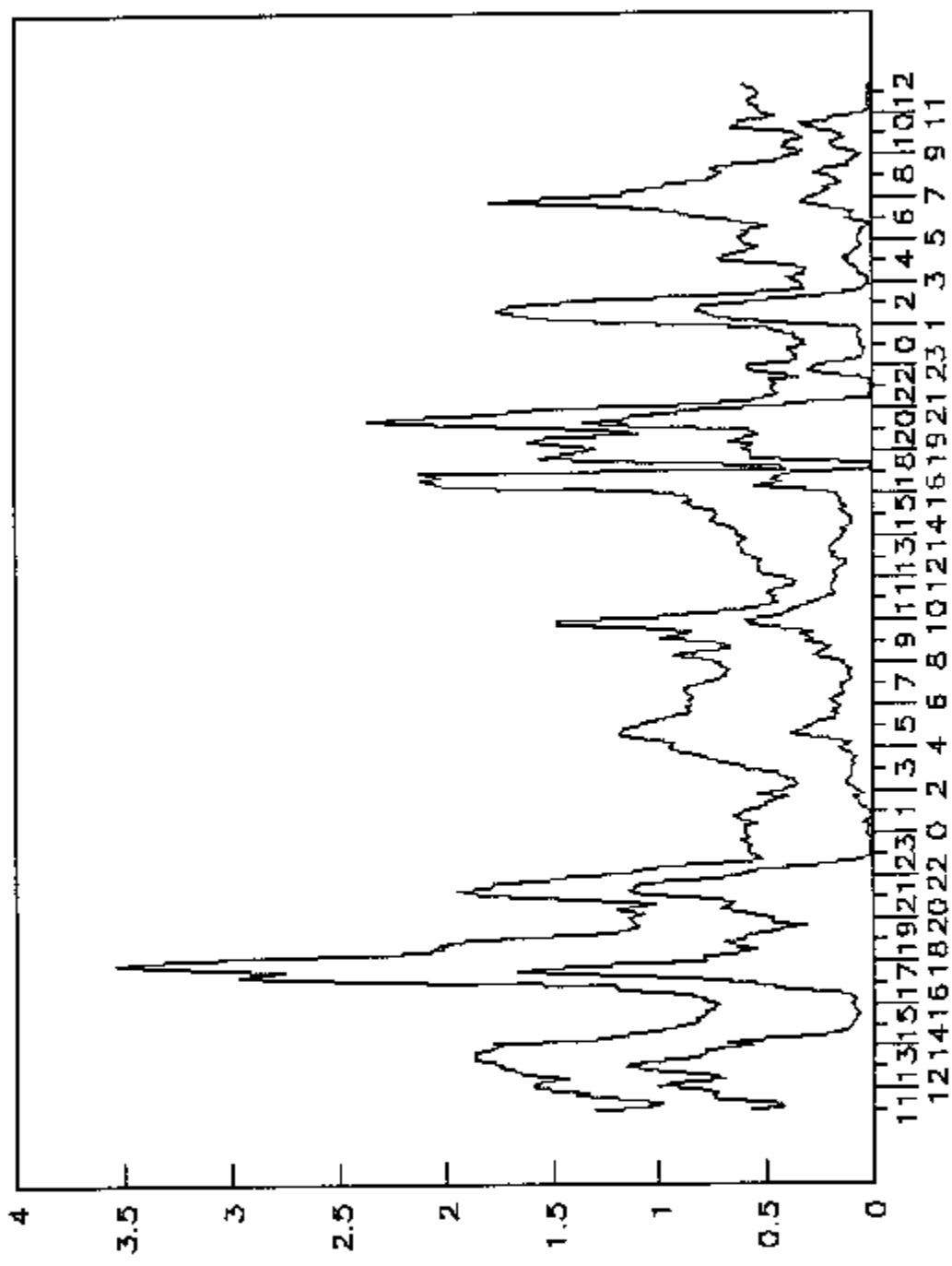

UV-6100 Ten Min Scans from Noon 5/2/93

—— Nitrate (NO3--N) - - - - Nitrite (NO2--N)

ppm Nitrogen

HOOKERS POINT DENITRIFICATION EFFLUENT

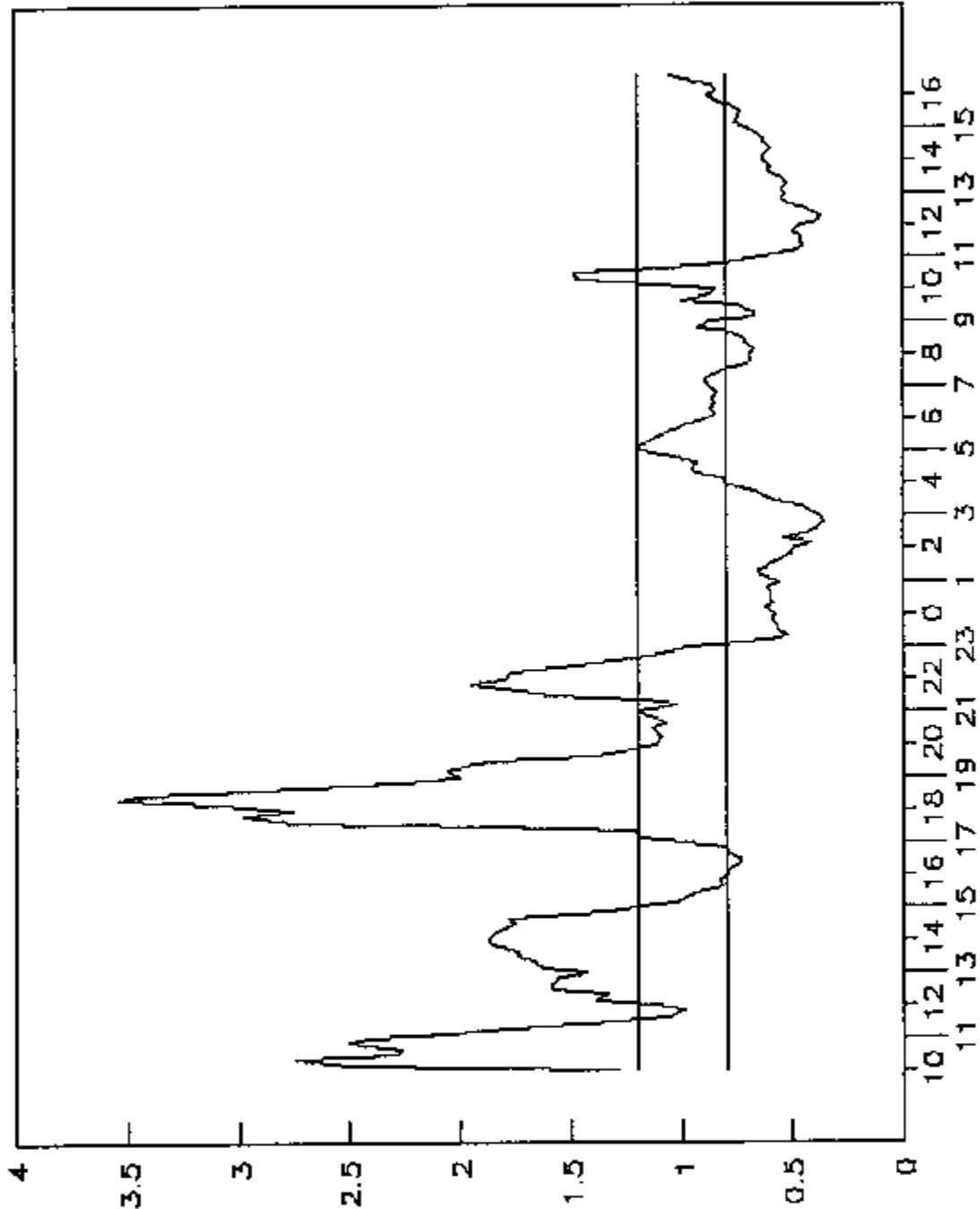

10 MIN INTERVAL FROM 10am 5/2/93

Tampa, Fl AWT Facility

Denitrification Effluent

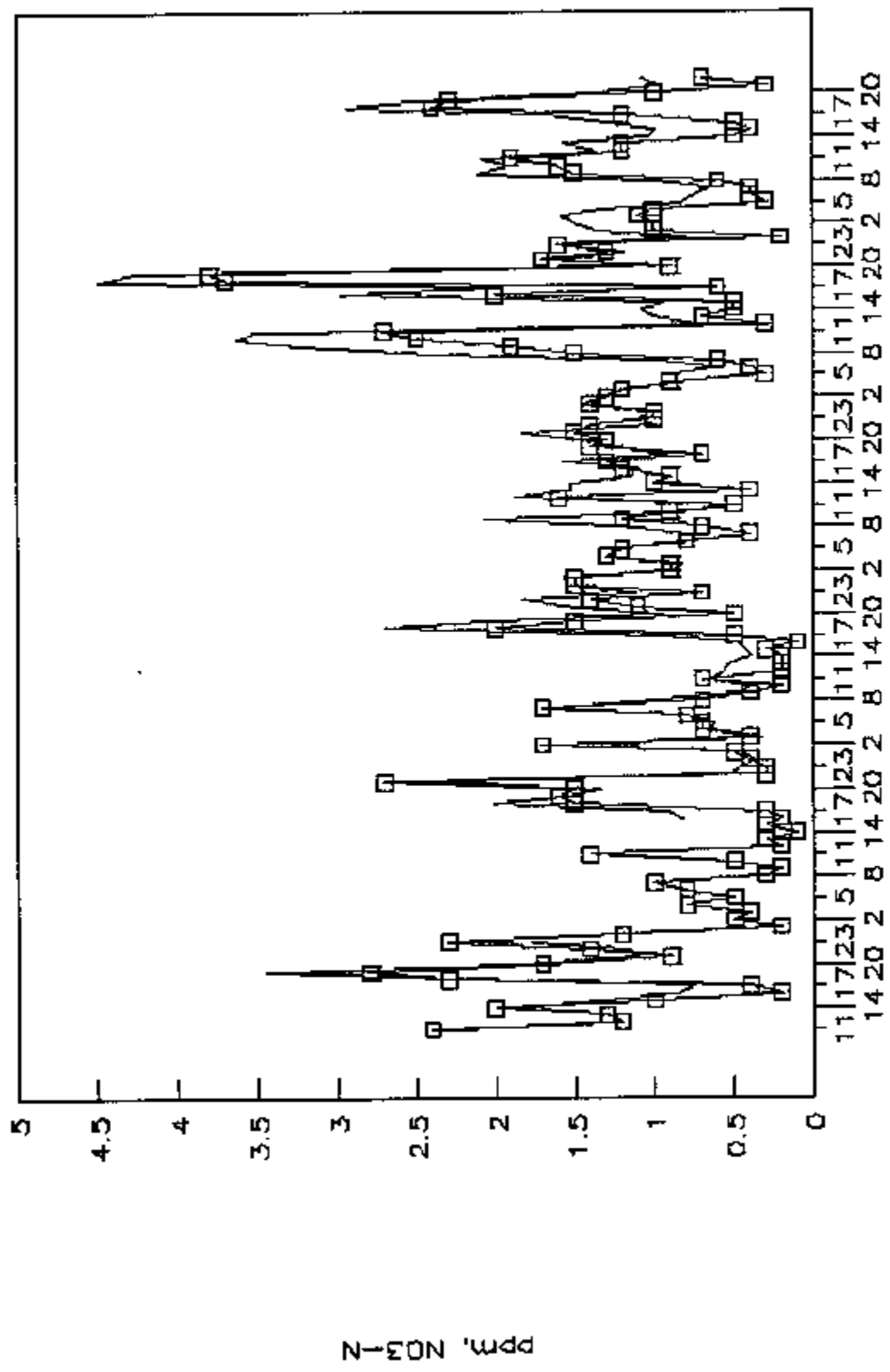

Comparison, Field Test Kit vs UV-6100
□ Field Test Kit — UV-6100 Analyzer

Tampa FL AWT Facility

Denitrification Effluent

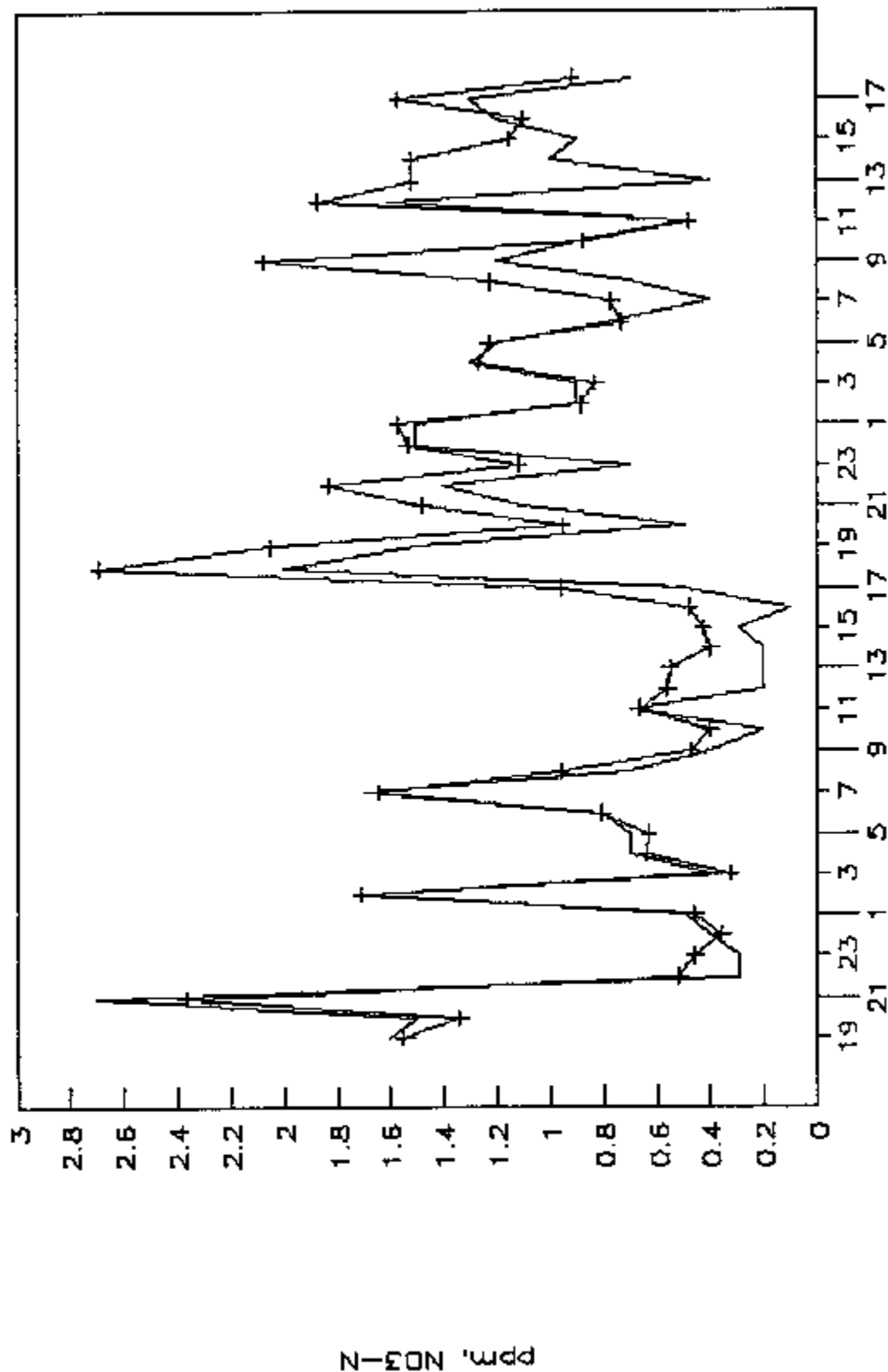

Hourly Values from 7pm 5/3/93

— Field Test Kit + UV-6100 Analyzer

Tampa Florida AWT Facility

Effluent from Denitrification Process

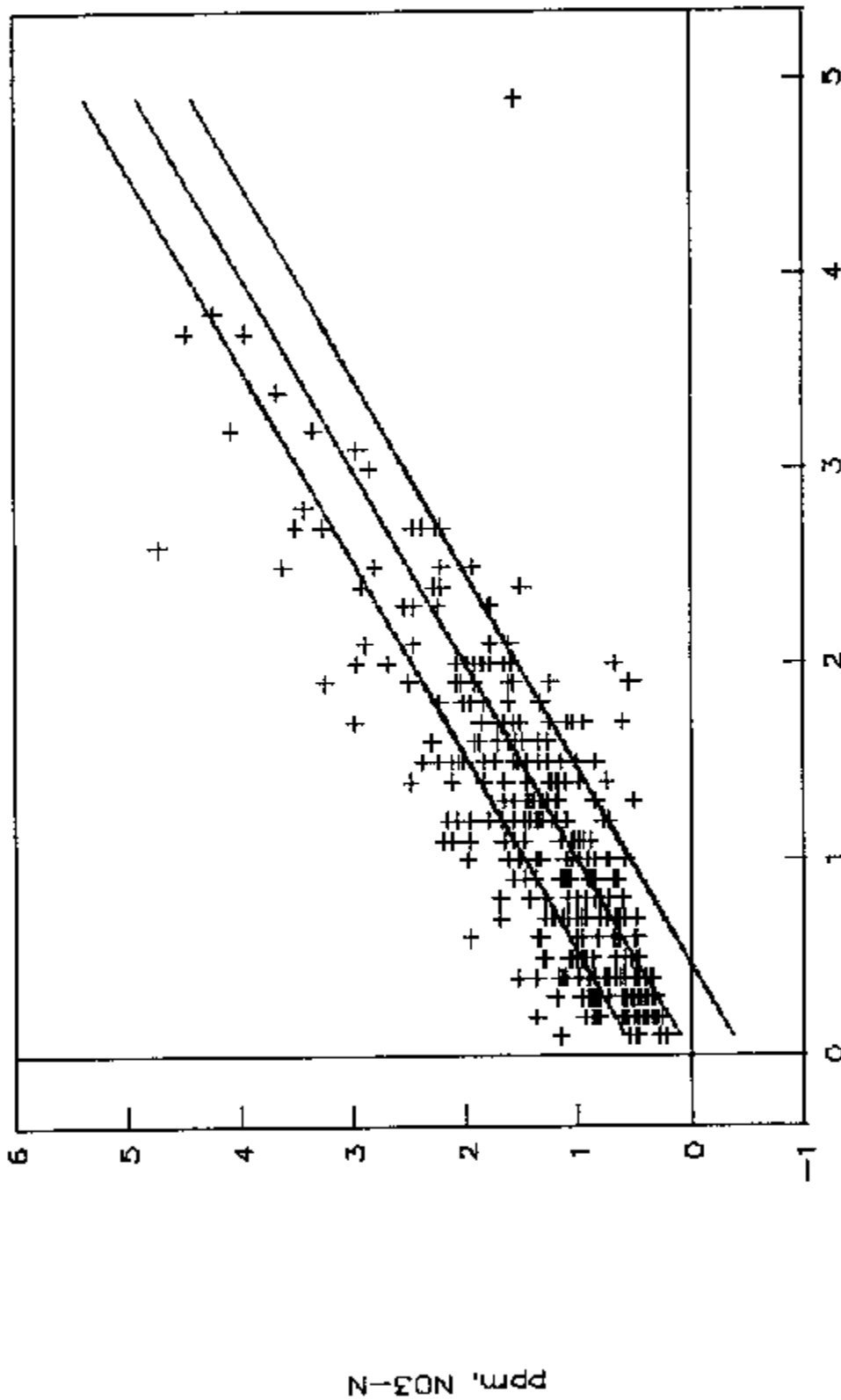

Test Kit vs UV-6100
— Test Kit +/- 1 SD + UV-6100 Analyzer

Tampa Florida AWT Facility

Effluent from Denitrification Process

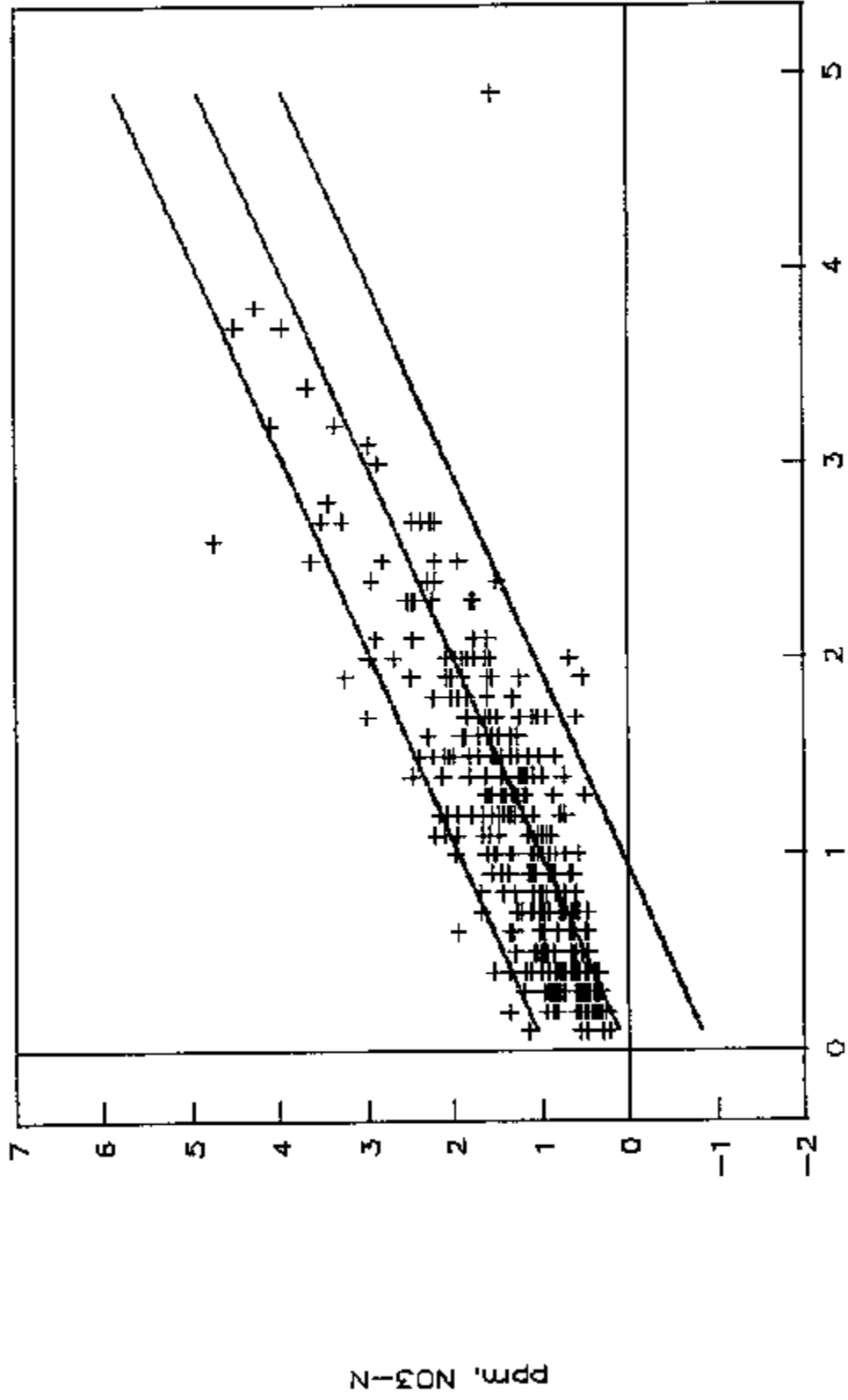

Test Kit vs UV-6100

— Test Kit +/- 2 SD + UV-6100 Analyzer

HOOKER'S POINT AWT

PLANT AND PROCESS DESCRIPTION

Page

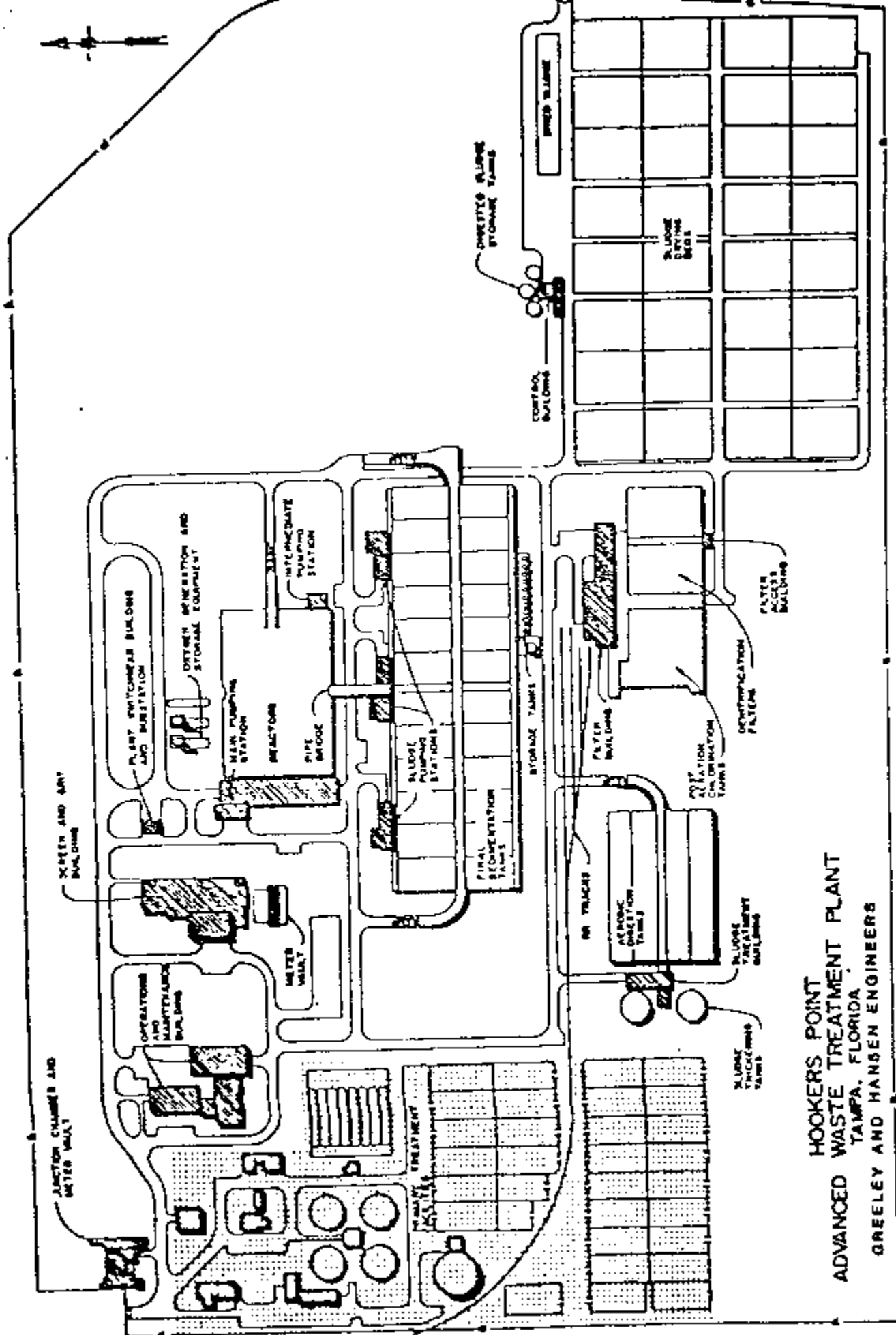

HOOKERS POINT
 ADVANCED WASTE TREATMENT PLANT
 TAMPA, FLORIDA
 GREELEY AND HANSEN ENGINEERS

HOOKERS POINT AWT PLANT
PROCESS DESCRIPTION

Preliminary treatment at the treatment plant includes preaeration of the sewage to remove hydrogen sulfide, treatment of the hydrogen sulfide for odor control, sewage screening, grit removal and primary sedimentation.

Chemicals may be added ahead of primary sedimentation to increase solids removal.

Secondary treatment for carbonaceous BOD₅ removal is provided by the activated sludge process in covered reactors in combination with final sedimentation tanks. Sewage enters the reactors in a plug flow pattern and is combined with return sludge to form mixed liquor. Mechanical aeration equipment is provided to transfer high purity oxygen to the mixed liquor in the reactors.

In the final sedimentation tanks, the solids (activated sludge) are removed from the mixed liquor by gravity settling. The solids (activated sludge) may then be returned to the reactors or wasted from the process as required.

The overall removal of carbonaceous BOD₅, and suspended solids after this activated sludge process is expected to be greater than 90 percent. Between 15 and 20 percent of the TKN will be removed with the suspended solids.

A second activated sludge process utilizing high purity oxygen for nitrification, which is the conversion of ammonia (NH_4^+) to nitrate ($-\text{NO}_3$) is provided in covered reactors in combination with final sedimentation tanks. Carbonaceous stage effluent enters the reactors in a plug flow pattern and is combined with the return sludge to form mixed liquor. Because of the high BOD₅ and suspended solids removal efficiency of the carbonaceous stage activated sludge process, a regulated stream of preliminary treatment effluent can bypass the carbonaceous stage and be fed directly to the nitrification stage to supplement the food supply required by the nitrifying bacteria. Mechanical aeration equipment is provided to transfer high purity oxygen to the mixed liquor in the reactors.

21

PROCESS DESCRIPTION
II-1-22

In the final sedimentation tanks, the solids (activated sludge) are removed from the mixed liquor by gravity settling. The solids (activated sludge) may then be returned to the reactors or wasted from the process, as required.

The overall removal of carbonaceous BOD₅, suspended solids after this activated sludge process is expected to be greater than 90 percent. Greater than 95 percent of the ammonia nitrogen in the influent to this activated sludge process will be converted to nitrate-nitrogen.

Denitrification is an anaerobic biological process, employed to convert the nitrate-nitrogen, in the effluent from the activated sludge-nitrification process, to nitrogen gas. Denitrification takes place in the deep bed, mono-media denitrification filters.

A supplemental carbon source (methanol) is added to the denitrification filter influent to provide a food source for the denitrifying culture in the filters.

There are twenty denitrification filters arranged for control in two groups of ten. There are three principle filter cycles, as follows:

- o Normal Filter Cycle
- o Nitrogen Release Cycle
- o Full Backwash Cycle

During the normal filter cycle, the nitrified effluent with the supplemental carbon source enters the filters and passes through the filter media where it comes in contact with the anaerobic denitrifying bacteria. It is here that the bacteria biologically dissimilate the nitrite to nitrogen gas.

The nitrogen gas forms small gas bubbles within the filter. The media and down flow of the liquid prevent much of the nitrogen gas bubbles from rising to the surface and escaping into the atmosphere. The nitrogen release cycle is a short backwash cycle to release the nitrogen gas which becomes trapped in the filter media. Generally, the nitrogen release cycle backwash will be requires at 4- to 6-hour intervals. If the nitrogen release back-

wash cycle is not performed at the required interval, the nitrogen gas will continue to accumulate and the head loss through the filter will increase just as in a dirty filter. The flow rate through the affected filter will be reduced. Automatic controls are arranged to provide an adjustable duration water backwash, in sequence, to each 10-filter group.

Greater than 90 percent of the nitrogen in the influent to this process will be converted to nitrogen gas and thereby, removed from the sewage.

As discussed above, denitrification is an anaerobic process. Therefore, the effluent from denitrification will have little or no dissolved oxygen (DO). Reaeration of the denitrification filters effluent is provided in the post aeration-chlorination tanks by diffused air. The DO in the sewage is raised to at least 5.0 mg/l.

Chlorination is provided in the post aeration -chlorination tanks for disinfection of the plant effluent. A chlorine residual of about 1.0 mg/l will be maintained. The chlorine is then removed by addition of sulfur dioxide.

Sludge removed by primary sedimentation is stabilized by anaerobic digestion in anaerobic digestion tanks which are a part of the primary treatment facilities. Waste sludge from the carbonaceous and nitrification activated sludge processes will generally be stabilized by anaerobic digestion. The gas from the anaerobic digestion process is burned in engines to produce electricity.

Sludge from the anaerobic digestion process is dewatered by belt filter presses or dried on sand drying beds.

The belt press sludge is then dried to produce a fertilizer product in a heat drying plant. This sludge product goes to distribution and marketing. Sludge that is not dried at heat drying is applied to agricultural land.

CITY OF TAMPA
HOOKEYS POINT AWT PLANT
PROCESS FLOW SCHEMATIC
60 MGD AVG DAILY FLOW

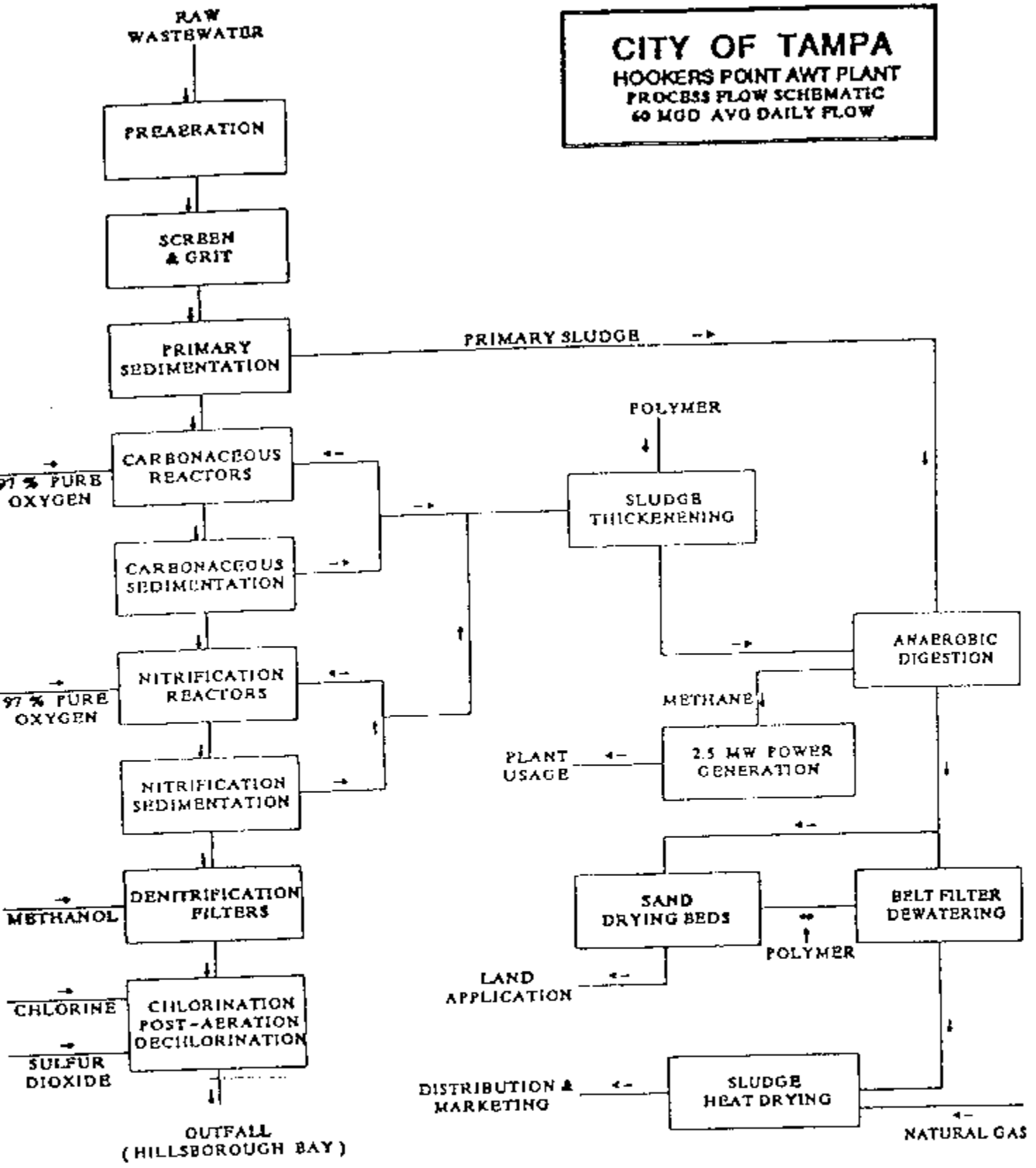

May 12, 1997

ADDENDUM 1

In October 1995 an order was placed by the City of Tampa for a ChemScan Process Analyzer System.

This system is currently installed and operating at the Howard F. Curren Wastewater Treatment Facility (formerly known as Hookers Point). The delivered system differs from the demonstration system in the following manner:

- a. The delivered system has a six sample line manifold and a series of manual valves which permit a choice of sample points for the "old" and "new" nitrification tank effluents, the "old" and "new" denitrification filter banks and the final plant effluent.
- b. Nitrite has been dropped as a parameter for the delivered system.
- c. Ammonia has been added as a parameter for certain sample points. The delivered system includes an ammonia sample conditioning unit.
- d. Automatic zeroing and cleaning is available on the delivered system.

"NITRIFICATION"

"DENITRIFICATION"

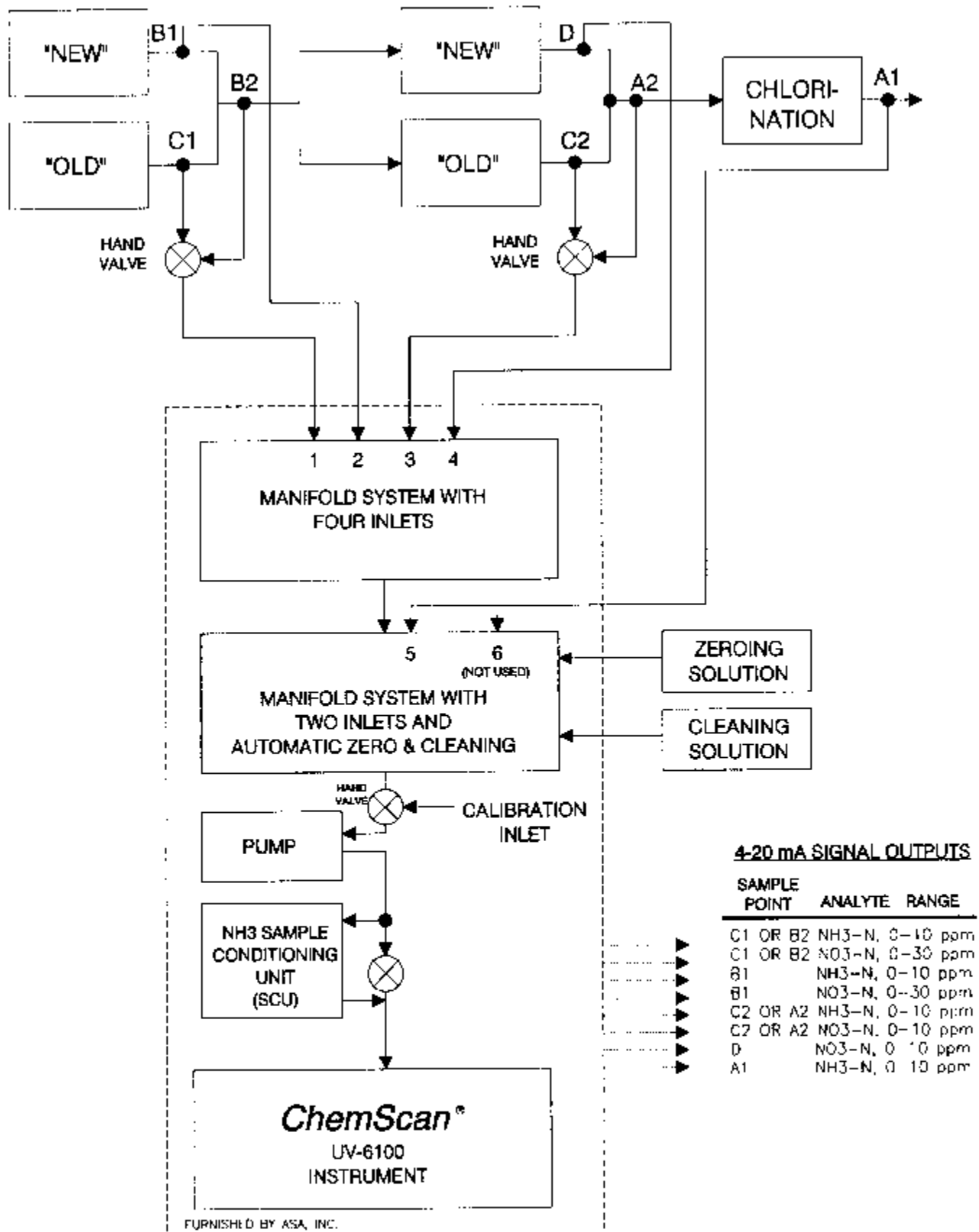

Denitrification Monitoring System
as built for
City of Tampa at Hookers Point WWTP
Revised March 25, 1996

Sample Point Connections

Sample Point	ASA Manifold Position	Analytes	Notes
C1-Nitrified Effluent from FB-SSP-1 (without methanol) (old) OR B2- Combined Nitrified Effluent from FB-SSP-7	1	NO3-N (0 - 30 ppm) NH3-N (0 - 10 ppm)	Manual Valve before ChemScan manifold to select either C1 or B2
B1- Nitrification Effluent from FB-SSP-6 (new)	2	NO3-N (0 - 30 ppm) NH3-N (0 - 10 ppm)	
C2- Denitrification Effluent (old) from FB-SSP-3 OR A2- Combined Denitrification Effluent from FB-SSP-5	3	NO3-N (0 - 10 ppm) NH3-N (0 - 10 ppm)	Manual Valve before ChemScan manifold to select either C2 or A2
D- Denitrification Effluent (new) from FB-SSP-4	4	NO3-N (0 - 10 ppm)	
A1- Final Effluent from CA-SSP-1	5	NH3-N (0 - 10 ppm)	